

# PD1104Z2-EI

4 MP intelligent PTZ camera 36x zoom, IR

## DESCRIPTION

The PD1104Z2-EI is a 4-megapixel IP outdoor PTZ dome camera without a bubble. A powerful high-grade 36x optical zoom lens ensures sharp and clear images over a wide range. The integrated IR illumination ensures crispy images over 200 m in no light conditions. The high-speed pan, tilt, and zoom mechanism and auto-focus give instantaneous and stable focused images. The camera is fitted with several intelligent features making video surveillance easy.

## FEATURES

- 1/1.8 Progressive scan CMOS imager
- 4MP @ 60 fps
- 36x optical zoom, 16x digital zoom
- 400°/s preset speed
- Integrated IR illumination up to 200 m
- 120 dB WDR (HDR)
- Supports EIS, Defog, BLC, and HLC
- Intelligent VCA, Auto tracking, AI
- IP67 and vandal proof IK10
- ONVIF Profile S and G conformant



## Description

### Multi-stream high definition

The integrated camera has multi-stream capability for simultaneous streaming of H.265, H.264 or MJPEG. Multiple combinations of resolutions and frame rates can be configured to satisfy different live viewing and recording scenarios.

### Open standards

Multiple options are available to easily integrate the PD1104Z2-E to a video management system. In support of open standards, the PD1104Z2-E is compliant with a range of VMS's, it supports ONVIF (Profile S and G) and the Siquira API.

### Power source choices

The PD1104Z2-E can be powered with 24 Vac or over the network with Hi-PoE sources. (802.3bt Type 3: max 60 W)

### Image enhancement

A wide variety of features can be used to increase image quality and fluency such as high dynamic range (120 dB WDR), defog, BLC and HLC. With regional cropping, details can be seen in the image even with low bandwidth.

### Built-in analytics

The camera features an extensive set of intelligent analytics, such as Object Abandoned, Object Removal, Face Detection, Audio Exception Detection, auto tracking, which assists the operator in detecting any anomalies and watching over your safety. Embedded deep-learning based object classification will reduce false alarms caused by leaves, shadows, grass, etc.

Camera	
Image sensor	1/1.8" Progressive scan CMOS
Effective pixels	2560 1440 (16:9)
Min. illumination	0.002 lux Color, 0.0002 lux B/W (F/1.5, AGC on)
Shutter speed	1 to 1/30,000 sec
Day/Night	IR-cut filter
Lens	36x zoom
Focal length	5.7 (F/1.5) to 205.2 mm (F/4.5)
Horizontal field of view	59.8° (W) to 2.0° (T)
Minimum focus distance	10 mm (W) to 1500 mm (T)
Lens material	High-grade optical glass
IR illumination	850 nm
IR range	200 m

PTZ	
Pan range	360° Continuous rotation
Tilt range	-20° to +90°
Number of presets	300
Preset speed	400°/s
Manual speed	0.1°/s to 350°/s Pan; 0.1°/s to 240°/s Tilt
Preset accuracy	0.225°
Features	Preset/Auto Scan/Tilt Scan/Random Scan/Frame Scan/Panorama Scan
Pattern Scan	4 pattern scans, record time over 10 minutes for each scan
Patrol Scan	8 patrols, up to 32 presets for each patrol
Body material	Aluminum alloy and ABS
Internal demister/heater	Standard

Image control	
Dynamic range (WDR)	120 dB, HDR
White balance	Auto/Manual/ATW (Auto-tracking White Balance) /Indoor/Outdoor/ Fluorescent Lamp/Sodium Lamp
Image settings	Sharpness, Brightness, Contrast, Color, EV
SNR	Better than 50dB
Noise reduction	3DNR
Electronic Image Stabilization (EIS)	Yes
Image enhancement	HLC/BLC/Defog/Regional Exposure/Regional Focus
Digital zoom	16x
Picture overlay	Picture can be overlaid on video with 512x512 24-bit bmp format Text, date & time, compass
Privacy masks	24 programmable polygon privacy masks

Video	
Video compression	H.265 (MP/+), H.264 (BP/MP/HP/+), MJPEG
Video bit rate	32 kbps to 16 Mbps

# Specs



Video	
Max resolution	2560x1440
Max frame rate	50/60 fps (120dB WDR= off)
Main Stream	
H.265/H.264/MJPEG @ 25/30 fps	2560x1440, 2048x1536, 1920x1080, 1280x960, 1280x720
H.265/H.264/MJPEG @ 50/60 fps	1920x1080, 1280x960, 1280x720
Sub Stream	
H.265/H.264/MJPEG @ 25/30 fps	704x576, 640x480, 352x288
Third stream	
H.265/H.264/MJPEG @ 25/30 fps	1920x1080, 1280x960, 1280x720, 704x576, 640x480, 352x288
Analog video output	PAL/NTSC (BNC on breakout cable)
Audio	
Audio compression	G.711/G.722.1/G.726/MP2L2/PCM
Audio bit rate	64 kbps (G.711) / 16 kbps (G.722.1) / 16 kbps (G.726) / 32-160 kbps (MP2L2)
Environment noise filtering	Support
Audio Input	1x Mic in/Line in interface, 2-2.4Vpp 1k, 10%
Audio Output	1x Audio output interface Line level, impedance: 600
Audio sampling rate	16 kHz / 32 kHz / 44.1 kHz / 48 kHz
Digital I/O	
Number of inputs	7, common ground
Number of outputs	2, galvanic isolated
Analytics	
Behavior analytics	Line Crossing Detection, Loitering Detection, Object Abandoned, Object Removal Region Existing, Region Entrance, Audio Exception Detection
Face detection	supported
Auto tracking	Manual Tracking, Auto Tracking, Event Tracking (support tracking specified target types such as human and vehicle)
Network	
Network storage	Micro SD/SDHC/SDXC up to 256 GB; NAS (Support NFS, SMBv1/CIFS)
Protocols	IPv4/IPv6, HTTP, HTTPS, 802.1x, QoS, FTP, SMTP, UPnP, SNMP, DNS, DDNS, NTP, RTSP, RTP, RTP, TCP/IP, DHCP, PPPoE, UDP, ICMP, DHCP, IGMP, SNMP v1/v2c/v3, ARP, Bonjour, Diamond
Security	3-level user authentication (ID and PW), Host authentication (MAC address); HTTPS encryption; IEEE 802.1x port-based network access control; IP address filtering
Standard	ONVIF (Profile S, Profile G), PSIA, CGI, ISAPI, Siqura API
Web browser	IE 9, 10 and 11; limited support for Edge, Chrome, Firefox
Environmental	
Ingress protection level	IP67
Impact protection	IK10
Overvoltage protection	Lightning Protection, Surge Protection and Voltage Transient Protection

# Specs



## Environmental

Ambient operating temperature	-40 °C to +65 °C (-40 °F to +149 °F),
Relative humidity	5 to 100%
Power supply	24 Vac 10%, 802.3bt Type 3 (Hi-PoE, 50 W)
Power consumption	Max. 60 W

## Mechanical

Interfaces	Break-out cable
Dimensions	diameter 266.6 x 410 mm
Weight	8 kg
Color	RAL 9003 (signal white)







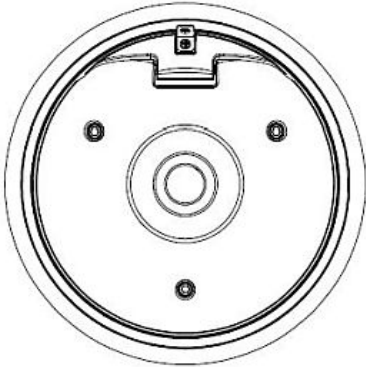
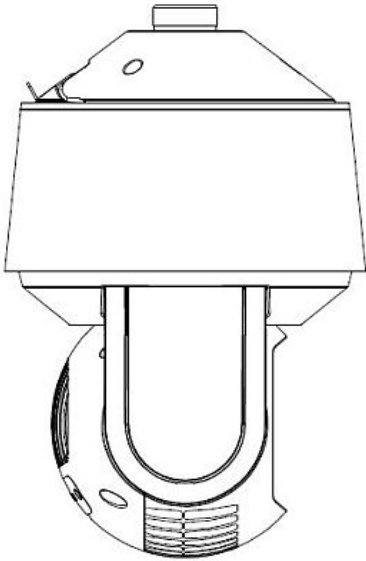
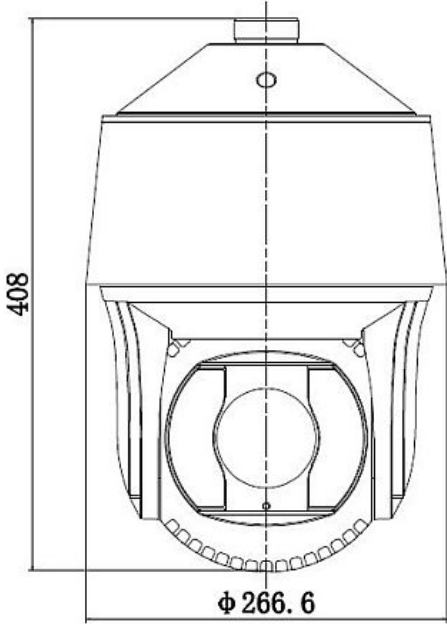



## Ordering information

PD1104Z2-EI	4 MP intelligent PTZ camera 36x zoom, IR
-------------	--

DIMENSIONS IN MM



Unit:mm

PD1104Z2-E(I)	Accessories
	<b>CM11</b> Ceiling mount for PD1100 series
	<b>CM12</b> Ceiling mount for PD1100-series, 50 cm
	<b>CM15</b> Ceiling mount for PD1100-series, 25 cm
	<b>PM07</b> Pole and wall mount for PD1100 series
	<b>PM07B</b> Pole, wall and box mount for PD1100 series
	<b>PM08</b> Pole parapet mount for PD1100 series
	<b>WM12</b> Wall mount for PD1100 series
	<b>WM12B</b> Wall and box mount for PD1100 series
	<b>WM16</b> Gooseneck mount for PD1100 series
	<b>WM17</b> Corner and wall mount for PD1100 series
	<b>WM17B</b> Corner, wall and box mount for PD1100 series

## RELATED

---



**Siqura PTZ Dome Mounts**  
PTZ dome mounting accessories

---